

FAX NO.
(904) 641-1697

Coastal Industries Inc.

P.O BOX 16091
JACKSONVILLE, FLORIDA 32246

TELEPHONE NO.
(904) 642-3970

*** Paragon
Bi - Fold Door

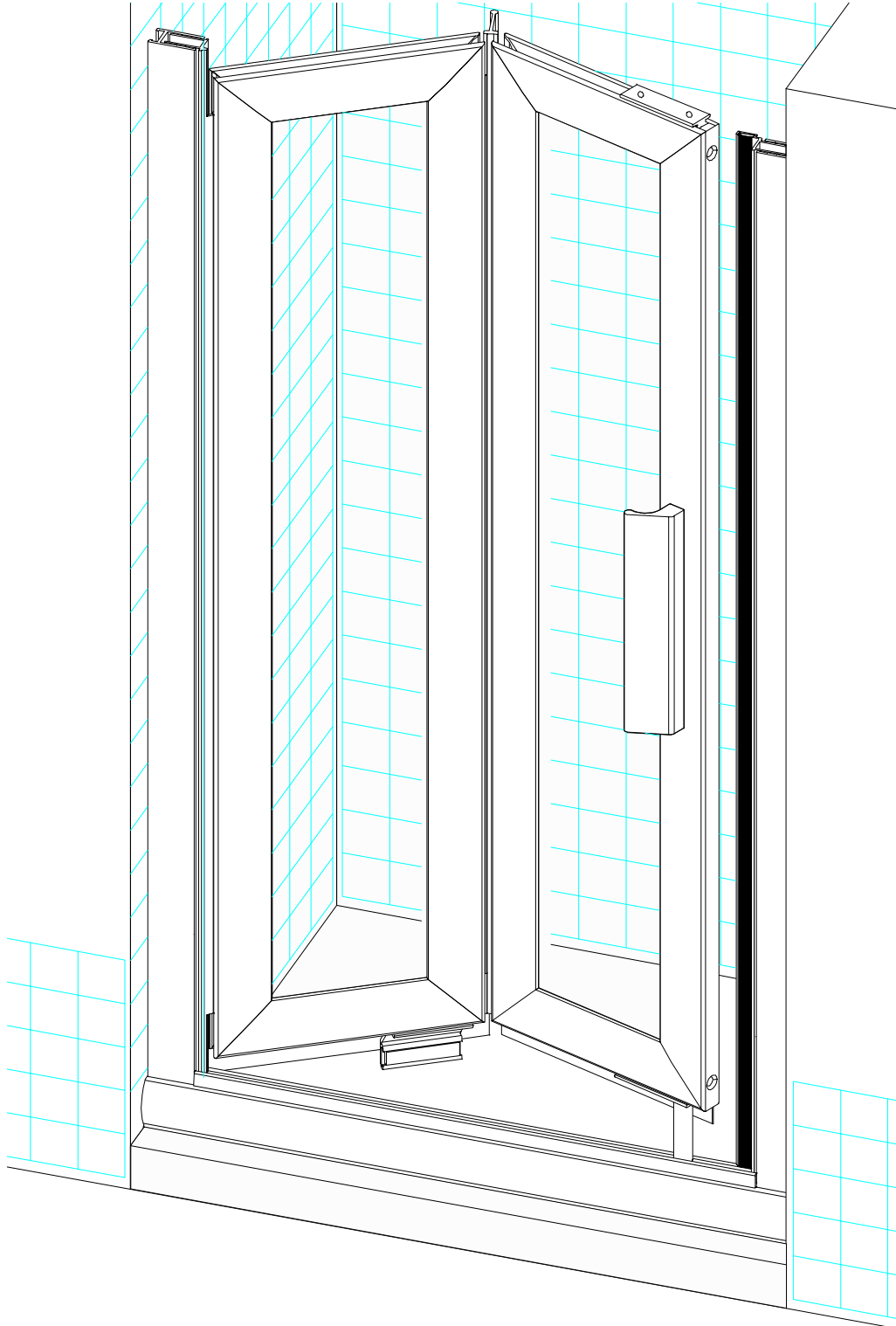

Paragon

Bi - Fold Door (right strike configuration shown)

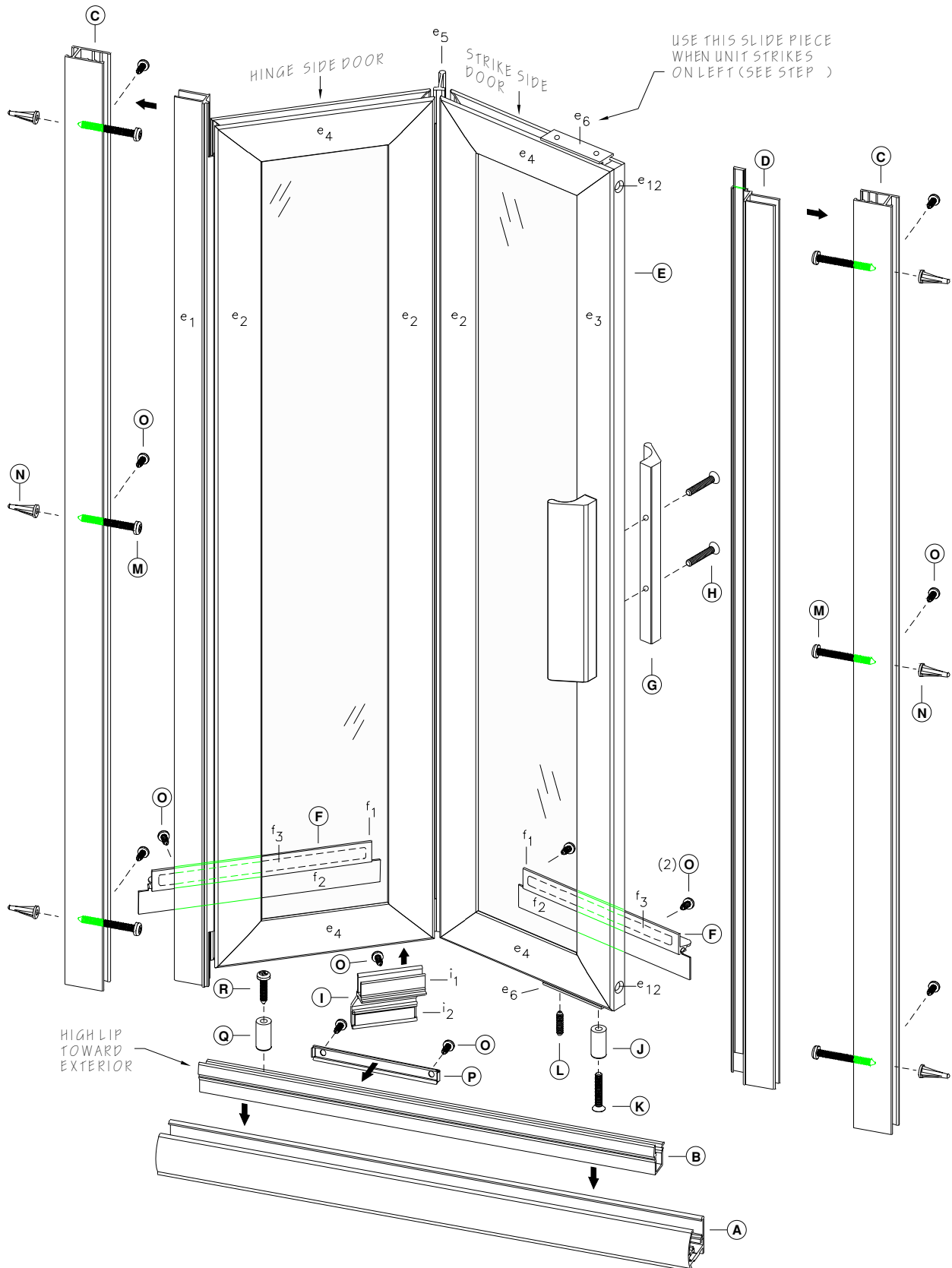

Exploded View - Outside of Unit Looking In

PARTS

KEY LETTER	PART NUMBER	DESCRIPTION	QTY
A	900	SILL	1
B	941	GUIDE TRACK, SILL	1
C	903	WALL JAMB	2
D	926	STRIKE POST	1
E		DOOR ASSEMBLY	
e1	920	Hinge Post	1
e2	922	Hinge Stile	3
e3	924	Strike stile	1
e4	925	Rail	4
e5	940	Center Hinge Pull	1
e6	37	Slide Piece	2
e7	CP932	Hinge Pins (not shown)	6
e8	CP148TW	Hinge Washer (not shown)	6
e9	C921B	Hinge Sleeve (not shown)	3
e10	C940B	Glazing Vinyl (not shown)	---
e11	98-42	Magnetic Strip (not shown)	1
e12	6-8114FHP	Door Panel Assembly Screws	8
F		DRIP RAIL ASSEMBLY	
f1	2340	Drip Rail	2
f2	C176G	Vinyl Door Sweep	2
f3	4403	Drip rail Tape (installed)	2
G	CP930	DOOR HANDLE (set)	1
H	6114MSFHP	DOOR HANDLE SCREWS	2
I		MAGNET HOLDER ASSEMBLY	
i1	942	Magnet Holder	1
i2	98-44	Magnet	1
J	SP189B	BUSHING (3/4" x 3/8" O.D.)	1
K	81MSFHP	BUSHING SCREW	1
L	83212SS	SET SCREW	2
M	6-8114PHP	INSTALLATION SCREWS	6
N	1329	PLASTIC SCREW ANCHORS	6
O	638PHPT	ADJUSTMENT SCREWS	12
P	CP935	STRIKE PLATE	1
Q	SP116B	DOOR STOP (1/2" x 5/16" O.D.)	1
R	634	DOOR STOP SCREW (#6 x 3/4")	1

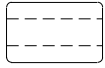

(Q)_DOOR STOP

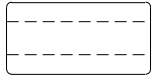

(J)_BUSHING

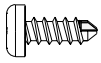

(O)_638PHPT ADJUSTMENT SCREW



(R)_634 DOOR STOP SCREW



(K)_81MSFHP BUSHING SCREW



(H)_6114MSFHP DOOR HANDLE SCREW

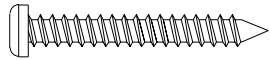

(M)_6-8114PHP UNIT INSTALLATION SCREW

INSTALLATION INSTRUCTIONS

1. Measure the base opening along center of shower curb as shown in figure 1. Trim Sill (A) to 1/16" less than measurement obtained.

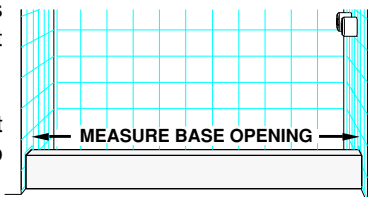

figure 1

2. With weep holes toward interior of enclosure, position Sill at center of shower curb. Temporarily tape Sill to shower curb to prevent movement.

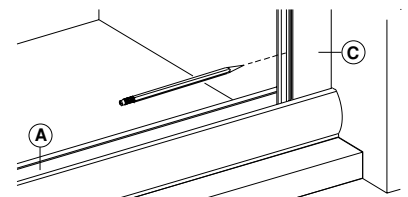

figure 2

3. Place Wall Jamb (C) into ends of Sill (A) and up against shower walls as shown in figure 2. Plumb the Jamb, then pencil mark their installation holes locations on the shower walls (3 per jamb). Remove Wall Jamb. Using a 3/16" masonry bit, drill 1" deep installation holes in locations previously marked. Insert Plastic Screw Anchors (N) into holes.

4. Reposition Wall Jamb (C) as before and secure Jamb to walls using the six(6) 1-1/4" Installation Screws provided (3 per jamb).

5. Before proceeding, determine which side you want your door to strike (left or right, your choice). Now measure the opening width between the two Wall Jamb (C) as shown in figure 3 and trim the **strike side end** of Sill Guide Track (B) to measurement obtained (**always trim the strike side end, never the hinge side end**). With Guide Track's **high lip toward exterior**, snap Track (B) into place as shown. See also exploded view - sheet 2.

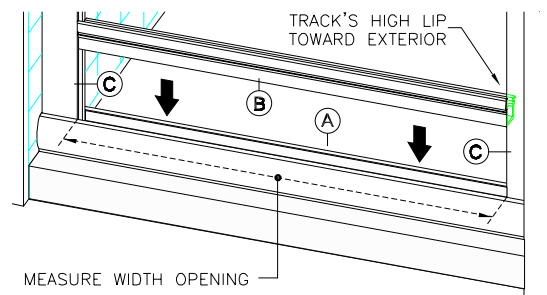

figure 3

6. Strike side was determined in step 5 . . . insert Strike Post (D) into the appropriate Wall Jamb (C), magnet should be facing toward exterior of enclosure, see exploded view - sheet 2.

7. Before proceeding with Door Assembly installation, note that the Door Assembly (E) must always fold in toward interior of shower enclosure (see explode view - sheet 2). Position Door Assembly on floor the way it will be installed on enclosure (remember, unit must fold into enclosure). Install Pivot Bushing (J), Pivot Bushing Screw (K) and Slide Piece Set Screw (L) onto appropriate Slide Piece (e6) as shown in figure 4.

8. Install Magnet Holder Assembly (I) onto the bottom rail (e4) of the "hinge side door" as shown in exploded view - sheet 2. Note that Magnet Holder Assembly is installed as close to Center Hinge Pull (e5) as possible. Magnet (i2) must face toward the outside of the shower enclosure as shown in figure 5.

9. Clean bottom rails of Door Assembly with alcohol to remove any oil. Failure to clean door rails prior to installation of Drip Rails (F) may cause tape to release. Remove backing from tape and position Drip Rails flush with edges of Hinge Stiles (e2) as shown in figure 6 and flush with bottom of Door as shown in figure 7. Secure Drip Rails to Door Panels using four 638phpt Screws (O) as shown in exploded view - sheet 2 and figure 5.

10. Insert the Door Assembly's Hinge Post (e1) into the Post from which it is to swing. Bring the Hinge Post to rest atop the Guide Track (B) and insert the Pivot Bushing (J) into the Guide Track cavity. Remember that regardless of whether the door strikes on the left side or the on the right side . . . the Door Assembly must always fold in toward interior of shower enclosure. Temporarily leave as is.

11. Attach the Door Handles (G) to the door using two(2) Door Handle Screws (H) as shown in exploded view - sheet 2.

12. Step inside the shower enclosure and close the Door. Check to make sure that bottom of Door Assembly (E) is parallel to the Sill (A). If it is not, make it so. When satisfied that the Door Assembly is parallel to the Sill, secure Hinge Post (e1) and Strike Post (D) to the Wall Jambs using six(6) 638PHPT Installation Screws (O) see exploded view - sheet 2.

13. Attach and center the Strike Plate face to the Magnet Holder Assembly and shown in figure 8a. Step inside the shower enclosure, close the door and mark the Strike Plate hole locations on the Sill. Open the Door , drill the hole locations and secure the Strike Plate to the Sill with two(2) 638phpt Screws (O) as shown exploded view sheet 2 and figure 8 below.

14. The purpose of Door Stop (Q) is to prevent the Door Panels from hitting upon themselves. Using the pre-drilled pilot hole in the Guide Track's bottom, secure Door Stop (Q) to the Guide Track with one(1) Door Stop Screw (R) as shown in figure 9.

15. Run a bead of clear mildew resistant caulking down the full length of each Wall Jamb **outside** where the Jambs meet the Walls. Now run a bead **outside** where the Sill meets the curb. Follow caulking manufacturer's instructions before using shower (normally 24 hours). Installation is now complete.

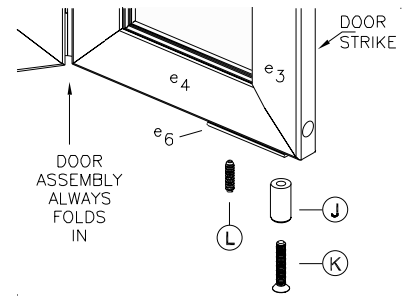

figure 4
(figure shows parts installed for a right hand strike Door)

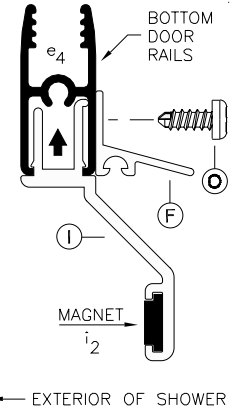

figure 5
(Snap Magnet Holder Assembly into bottom rail as shown, see also exploded view - sheet 2)

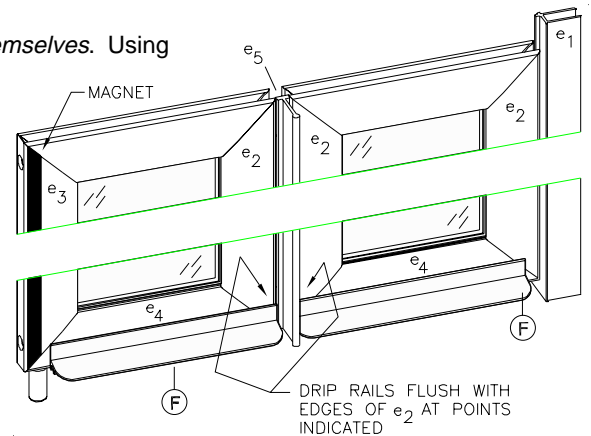

figure 6
(figure shows from inside of unit looking out)

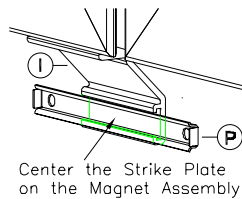

figure 8a

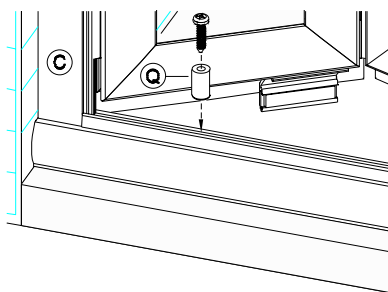

figure 9

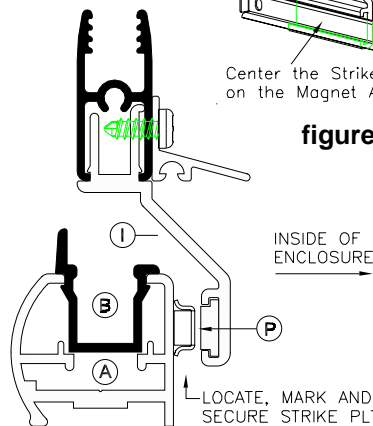

figure 8

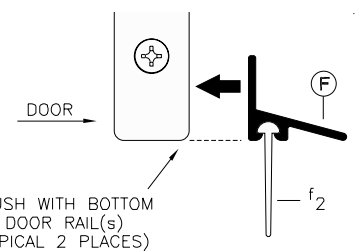

figure 7