

FAX NO.  
(904) 641-1697

# Coastal Industries Inc.

P.O BOX 16091  
JACKSONVILLE, FLORIDA 32246

TELEPHONE NO.  
(904) 642-3970

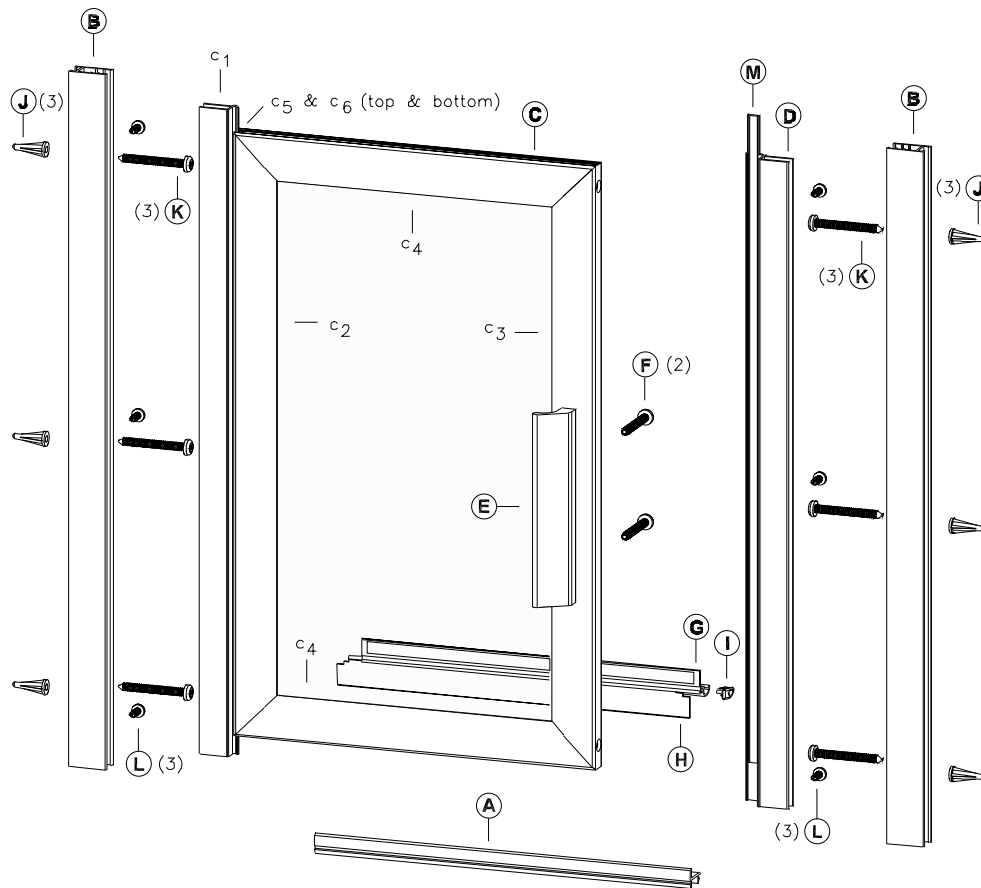

## Paragon Door Installation Instructions (exploded view, left hand hinge shown)

KEY LETTER	PART NUMBER	DESCRIPTION	QUANTITY
A	901	SILL	1
B	903	WALL JAMB	2
C	---	DOOR ASSEMBLY	1
c1	920	Hinge Post	1
c2	922	Hinge Stile	1
c3	924	Strike stile	1
c4	925	Rail	2
c5	CP932	Hinge Pins (not shown)	2
c6	CP148TW	Hinge Washer (not shown)	2
c7	C921B	Hinge Sleeve (not shown)	1
c8	C940B	Glazing Vinyl (not shown)	---
c9	98-42	Magnetic Strip (not shown)	1
c10	6-8114FHP	Door Panel Assembly Screws	4

KEY LETTER	PART NUMBER	DESCRIPTION	QUANTITY
D	926	STRIKE POST	1
E	930	DOOR HANDLE (SET)	1
F	6114MSFHP	DOOR HANDLE SCREWS	2
G	927	DRIP RAIL	1
H	C176G	VINYL DOOR SWEEP	1
I	CP933	DRIP RAIL PLUG SET	1
J	1329	PLASTIC SCREW ANCHOR	6
K	6-8114PHP	INSTALLATION SCREWS	6
L	638PHPT	ADJUSTMENT SCREWS	6
M	98-42	MAGNETIC STRIP	1

1. Measure the base opening along center of shower curb as shown, then trim Sill (A) to 1/16" less than measurement obtained.

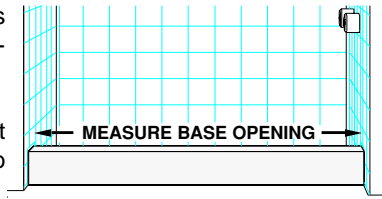

figure 1

2. With high lip toward exterior of enclosure, position Sill at center of shower curb. Temporarily tape Sill to shower curb to prevent movement.

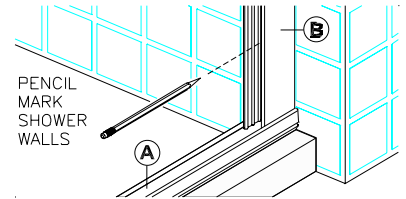

figure 2

3. Place Wall Jamb (B) on to ends of Sill (A) and up against shower walls as shown in figure 2. Plumb the Jamb, then pencil mark their installation holes locations on the shower walls (3 per jamb). Remove Wall Jamb. Using a 3/16" masonry bit, drill 1" deep installation holes in locations previously marked. Insert Plastic Screw Anchors (J) into holes.

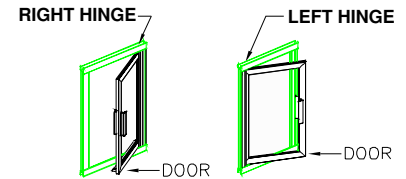

figure 3

4. Reposition Wall Jamb (B) as before and secure Jamb to walls using the six(6) 1-1/4" Installation Screws (K) provided (3 per jamb).

5. Decide from which side your Door Assembly (D) is to hinge (left or right, your choice) see figure 3. Insert the Door Assembly's Hinge Post (c1) into the Wall Jamb from which it is to hinge. Now, insert the Strike Post (D) into the other Wall Jamb (see exploded view - sheet 1). Magnet on door should face toward interior of enclosure, while magnet on Strike Post should face toward the exterior.

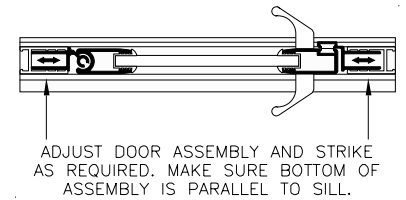

figure 4

6. Attach the Door Handles (E) to the Door Assembly using two(2) Door Handle Screws (F) as shown in exploded view - sheet 1.

7. Adjust Door Assembly and Strike Post along curb as required (see figure 4). Note: Bottom of Door Assembly must always remain parallel to Sill in order for door to operate properly (see figure 5). When satisfied with door operation, secure Hinge Post and Strike Post to the vertical posts using 638PHPT Installation Screws (L), see exploded view - sheet 1.

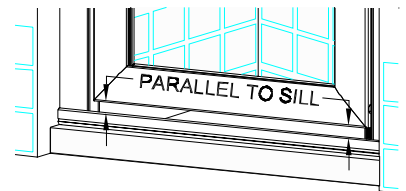

figure 5

8. Clean bottom rail of door with alcohol to remove any oil. Failure to clean door rail prior to installation of Drip Rail (G) may cause tape to release. Remove backing from tape and position Drip Rail flush with backside of Hinge Stile (c2) as shown in figure 6 and flush with bottom of Door as shown in figure 7. Slightly elevate Drip Rail at strike side before securing to create a sloping effect. Attach a Drip Plug (I) on strike side of Drip Rail (see exploded view - sheet 1).

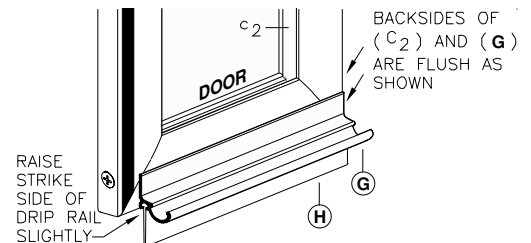

figure 6

9. Run a bead of clear mildew resistant caulking down the full length of each Wall Jamb **outside** where the Jamb meet the Walls. Now run a bead **outside** where the Sill meets the curb. Follow caulking manufacturer's instructions before using shower (normally 24 hours). Installation is now complete.

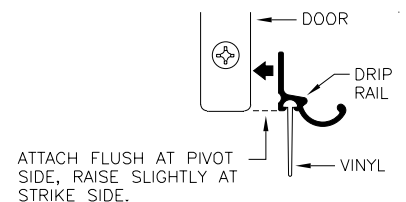

figure 7